

PestWest[®]
www.pestwest.com

Find us on:    



Confidence in
Fly Control

About Us

Find us on:



Supporting you with a comprehensive range of professional flying insect control units.

Innovation, quality and power are key components in all our units. Combining excellent value with expertise from technicians and leading biologists, PestWest offer a diverse range of flying insect control units.

OPERATING AND SUPPLYING TO SATISFIED CUSTOMERS WORLDWIDE

By merging science with technology, PestWest units are designed to the highest specification whilst always keeping the ease of maintenance in mind, saving you time and money.

PestWest are passionate about flying insect control, guaranteeing that you receive the very best units built to the highest specification.

PestWest is the proud holder of the Queen's Award for Enterprise: International Trade 2004, the holder of regional and national awards for export sales and is the winner of the UK award for Best Use of Education and Training. Additionally, flyDetect® from PestWest won the Best New Product Award 2020 at The Society of Food Hygiene and Technology Virtual Awards Ceremony and the Made in Yorkshire Award in July 2021.



Quality Products

Find us on:



Our high-quality flying insect control products are the preferred choice for many of the world's best 5-star resorts and hotels, franchised food outlets, hospitals, kitchens, supermarkets, food, packaging and pharmaceutical plants.

- We strive to continue our research and development, manufacturing new and improved products and delivering tangible benefits to public health, the environment and the community through the control of pests, diseases and infection.
- We provide the most cost-effective and environmentally responsible pest control solutions on the market.
- Each professional unit is fitted with environmentally responsible pestwest Quantum® shatterproof tubes.

ALL PESTWEST UNITS ARE CE AND UKCA MARKED AND CARRY THE REQUIRED IEC INTERNATIONAL APPROVALS.

ALL MODELS COME WITH A 3-YEAR GUARANTEE (EXCLUDING CONSUMABLES).

ALL PROFESSIONAL UNITS USE STEEL & STAINLESS STEEL CONSTRUCTIONS, LIMITING THE USE OF PLASTIC TO A MINIMUM.

Quality Service

Please don't hesitate to contact us for more information on our people, products or organisation.

- We pride ourselves on fast, reliable and efficient delivery of our products through most countries worldwide.
- We have a comprehensive, easy-to-use website providing detailed product descriptions and information about our company.
- To purchase one of our high quality products please contact us directly or one of our many partners.

Quality Management

We pride ourselves on our quality service and efficient management. Our British production site has an ISO 9001 certified Quality Management System.

- We have a dedicated management, sales and production team servicing many valued distributors and customers throughout the world.
- Our management ethos is simple: uncompromising first-class service, quality products and quality design.



Professional LED Sticky Traps

5 - 9



Professional Sticky Traps

10 - 14



Electronic Fly Killers

15 - 18



Decorative and Commercial Sticky Traps

19 - 21



Specialist Range

22 - 27



Flying Insect Surveillance Sticky Trap

28 - 29



Ancillary Products

30 - 33



Hints, Product Selection Guide & Product Specifications

34 - 37



Flying Insect Identification

38



Professional LED Sticky Traps

Find us on:    

The next generation of UV-A LED technology is here! All PestWest LED units incorporate the latest Quantum® X UV LED tube technology, to deliver a whole new level of fly control.

Unrivalled distribution of UVA LED light through 432 emission points per tube for optimum flying insect control.

Minimal energy consumption without any dimming, three times less than with conventional fluorescent tube technology and 35% less compared with most existing LED models.

Ease of servicing – LED tubes require replacement only once every 3 years.

Full metal construction with 304 food grade stainless steel option.

No mercury, low carbon & plastic footprints.

LED optimised sticky board.

Future-proof.

This is the UV-A tube technology the industry has been waiting for!



Professional LED Sticky Traps

Find us on:

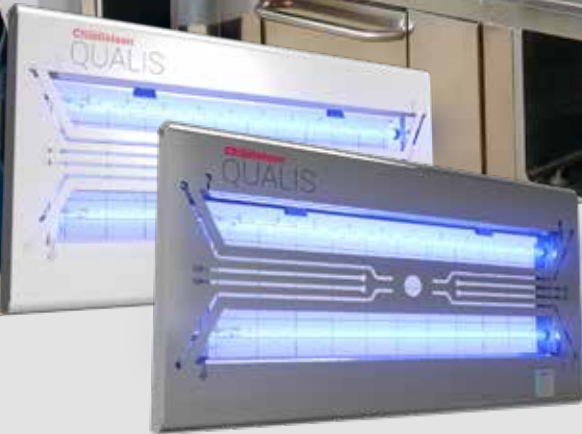

With its clean and modern design, the Chameleon® Qualis offers a whole new level of energy-efficient, sustainable fly control.

It is predominantly destined for the food and packaging industries, and commercial kitchens.

This unit is fitted with next generation Quantum® X LED filament tubes, coated with FEP shatter-resistant coating as standard, to allow for usage in glass exclusion zones.

The main advantages of the Quantum® X LED filament tube technology are the extended pattern of light distribution and the improved energy efficiency.

The Chameleon® Qualis is available with a white coated steel or 304 food grade stainless steel chassis.

Chameleon® QUALIS

QUANTUM®
LED

DIMENSIONS:

H: 30cm W: 57.5cm D: 4cm

WEIGHT:

3.6kg

COVERAGE:

Wall mounted: 90-120m²

FINISH:

White Stainless Steel

TUBE DATA:

- 2x Quantum® X LED tubes
- Shatterproof coating with industry compliant FEP
- Powered by a state of the art LED driver



Professional LED Sticky Traps

Find us on:

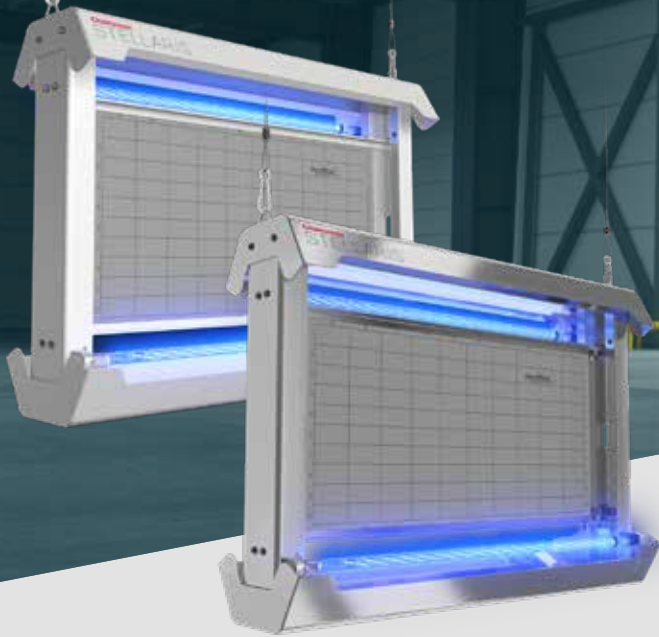

A unique double-sided LED UV fly control unit for large, open industrial areas.

The patent pending design maximises the 360° UV output of the Quantum® X LED technology to increase energy savings and reduce consumables with no compromise on fly control performance. The Chameleon Stellaris consumes 6 times less than its equivalent Chameleon model with fluorescent tubes and 3 times less than most other LED suspended models with a similar coverage area. Its full metal construction further reduces the environmental impact.

The servicing is fast and easy with direct access to consumables, notably the lateral insertion and withdrawal of the LED optimised glue boards.

Chameleon® STELLARIS X

QUANTUM
LED

DIMENSIONS:

H: 42cm W: 59cm D: 16cm

WEIGHT:

5.7kg

COVERAGE:

180-220m²

FINISH:

White Stainless Steel

TUBE DATA:

- 2x Quantum® X LED tubes
- Shatterproof coating with industry compliant FEP
- Powered by a state of the art LED driver

PestWest



Professional LED Sticky Traps

Find us on:



ON-TOP PRO

ON-TOP PRO2



Innovative, discreet and stylish fly traps; the unique overhead design fits discreetly and easily into new or existing suspended ceilings.

These discreet and stylish LED models are designed to be ceiling fitted into new or existing suspended ceilings. Their patented concept offers an ideal solution for supermarkets, convenience stores, fast-food outlets, and areas where space limitations made conventional installations difficult.

Both models are fitted with two Quantum® X LED shatterproof tubes and a large, polished aluminium reflector that will efficiently and economically control flying insect infestations in public spaces.

The ON-TOP PRO2 X features a pivotable curved stainless steel front holding the LED optimised glue board common with the other models of the range, whilst the ON-TOP PRO X matches the tile pattern of ceilings with its square cover holding two LED glue boards.

DIMENSIONS

OTP X: H: 59cm W: 59cm D: 15cm

OTP2 X: H: 59cm W: 59cm D: 7cm

WEIGHT

5.6kg

COVERAGE

Ceiling fitted: 50-60m²

FINISH

OTP X: White coated OTP2 X: Stainless Steel

TUBE DATA

- 2x Quantum® X LED tubes
- Shatterproof coating with industry compliant FEP
- Powered by a state of the art LED driver



Professional LED Sticky Traps

Find us on:   



The Chameleon® Sirius X is the next generation fly control unit for sophisticated front-of-house use. Sticking to the clean and futuristic design of the Chameleon® Sirius, it will continue to blend in seamlessly into any restaurant, café or hotel.

Fitted with two Quantum® X LED shatterproof tubes and the dedicated LED range glue board, the appealing unit helps to save energy and contributes to the wider mission of sustainability. Additionally, each centrally dividable replacement glue board gives two usages.

The Sirius X offers dual wall mounting options, either horizontally or vertically.

Chameleon® SIRIUS X

QUANTUM®
LED

DIMENSIONS

H: 19cm W: 58cm D: 12cm

WEIGHT

3.1kg

COVERAGE

Wall mounted: 50-60m²

FINISH

 White  Stainless Steel

TUBE DATA

- 2x Quantum® X LED tubes
- Shatterproof coating with industry compliant FEP
- Powered by a state of the art LED driver



Professional Sticky Traps

Find us on:



PestWest Professional Sticky Traps are high quality units combining advanced glue board technology with slim-line designs. The slim-line designs enable glue boards to be placed closer to the UV fluorescent tubes improving catch rates, whilst PestWest Reflectobakt® sleeves shield the board from the adverse effect of the UV tubes.

With a PestWest sticky trap the insects are secured allowing units to be placed closer to sensitive areas. They do not have an electric killing grid making them silent, discreet and hygienic whilst catching all sizes of insects, including smaller species such as Fruit Flies.

All units feature:

- Quantum® shatter resistant fluorescent tubes coated with industry compliant FEP for maximum attraction and significantly reduced risk of contamination from glass breakages.
- Full-size sticky board to effectively catch even the smallest flies.
- Easy to remove bottom tray, drop-down guard and front covers - no tool service.
- Reflectobakt® sleeves increase attractiveness to insects, significantly slow the drying of the sticky board and allow longer board life and slimmer design (excl. Uplight).
- Interchangeable tubes and sticky boards on all units to minimise stocking requirements.
- All metal construction means longer lasting models for years of reliable service.

Professional Sticky Traps

Find us on:



Attractive, slim, wall-mounted (free standing bracket available), compact and unobtrusive, this unit is ideal for use in food preparation areas.

Chameleon® 1x2 units are ultra-slim, easy to maintain, and only require a periodical change of glue boards and an annual tube replacement to keep optimum performance.

With the Chameleon® 1x2, insects are caught cleanly and safely onto the glue board. No noise, no smell, no problem. This allows the equipment to be placed closer to sensitive areas.

Chameleon® units from this range use interchangeable tubes and sticky boards to minimise stocking requirements.



Chameleon® 1x2

DIMENSIONS

H: 30cm W: 47.5cm D: 6.5cm

WEIGHT

4.3kg

COVERAGE

Wall mounted / Freestanding: 90m²

FINISH



White



Stainless Steel

TUBE DATA

- 2 x 15-Watt PestWest Quantum® tubes
- Shatterproof coating with industry compliant FEP
- Reflectobakt® technology

Find us on:



Chameleon® 1x2 DISCRETION

Discreet and slim wall-mounted unit (free-standing bracket available). An attractive front cover conceals the sticky board and catch, which makes this unit ideal for areas in view of the public.

This Chameleon® 1x2 Discretion offers very similar features as the standard 1x2, but with added discretion.

DIMENSIONS

H: 30cm W: 47.5cm D: 6.5cm

WEIGHT

4.3kg

COVERAGE

Wall mounted / Freestanding: 70m²

FINISH

White Stainless Steel

TUBE DATA

- 2 x 15-Watt PestWest Quantum® tubes
- Shatterproof coating with industry compliant FEP
- Reflectobakt® technology

Professional Sticky Traps

Find us on:



Designed to be ceiling-suspended, this model provides 360° attraction and is ideal for industrial and commercial food premises.

Populations of smaller flies are on the increase, putting jobs and reputations on the line. The double sided Chameleon® 2x2 protects large open areas and catches all sizes of flies, especially the smaller ones that may be missed by traditional units.

Chameleon® units from this range use interchangeable tubes and sticky boards to minimise stocking requirements.



Chameleon® 2x2

DIMENSIONS

H: 30cm W: 49.5cm D: 13cm

WEIGHT

6kg

COVERAGE

Ceiling-suspended / Freestanding: 180m²

FINISH

White Stainless Steel

TUBE DATA

- 4 x 15-Watt PestWest Quantum® tubes
- Shatterproof coating with industry compliant FEP
- Reflectobakt® technology

Find us on:



Chameleon® Uplight

DIMENSIONS

H: 21cm W: 47cm D: 17cm

WEIGHT

3.7kg

COVERAGE

Wall mounted: 40m²

FINISH

 White  Silver  Magnolia

TUBE DATA

- 1 x 15-Watt PestWest Quantum® tube
- Shatterproof coating with industry compliant FEP

Attractive wall-mounted unit disguised as a wall light. It is the perfect choice for areas where fly control should be discreet, e.g. restaurants and other eating areas.

Disguised as a wall sconce, the Chameleon® Uplight is easily mounted on the wall for years of reliable service. The front cover can be painted or decorated to match existing decor.

Electronic Fly Killers

Find us on:    

The Electronic Fly Killers use powerful PestWest Quantum® tubes to attract flying insects onto a high voltage killing grid to eradicate them. The insects subsequently fall into a catch-tray.

They are designed with both the professional technician and the end-user in mind.

They combine robust and powerful designs with tool-free maintenance and a choice of either wall-mounted, ceiling-suspended or freestanding installation.

Electronic Fly Killers

Find us on:



This all-metal electronic fly killer combines robustness and power making it the ideal choice for large open industrial areas away from exposed foodstuffs.

It features higher energy efficient UVA fluorescent tubes powered by a state of the art electronic ballast for optimum fly control performance with lower running costs and reduced materials (glass & mercury).

Additional features:

- Unique transformer - minimises shattering of insects
- Front guard lockable in open position - facilitates servicing
- 'Power-on' and 'grid-on' warning lights - inspection at a distance
- Spring-loaded removable killing grid - easy cleaning
- Choice of mounting option - ease of placement

Nemesis[®] QUATTRO

DIMENSIONS

H: 42cm W: 65cm D: 18cm

WEIGHT

12kg

COVERAGE

Wall mounted: 240m² / Ceiling-suspended: 480m²

FINISH

White Stainless Steel

TUBE DATA

- 4 x 14-Watt T5 PestWest Quantum[®] tubes
- Shatterproof coating with industry compliant FEP
- Powered by an electronic ballast

Electronic Fly Killers

Find us on:   



With a wrap-around chrome guard giving 360° protection, this all-metal unit offers outstanding fly control performance durably.

- High performance transformer.
- Multiple mounting options.
- Easy and fast to service without the need for tools.
- Removable spring-loaded killing grid for thorough cleaning.
- The Titan 300 is ideal for larger outlets and all commercial uses. It can cope with heavy fly infestations and be adapted to operate as a cluster fly unit by removing the tray.

TITAN[®] 300

DIMENSIONS

H: 33cm W: 49.5cm D: 13.5cm

WEIGHT

7.5kg

COVERAGE

Wall mounted: 90m² / Ceiling-suspended - Freestanding: 180m²

FINISH

 White  Stainless Steel

TUBE DATA

- 2 x 15-Watt PestWest Quantum[®] tubes
- Shatterproof coating with industry compliant FEP

Electronic Fly Killers

Find us on:



A powerful, economical & compact unit with two 15-watt Quantum® T5 tubes.

- Multiple mounting options.
- Easy and fast to service without the need for tools.
- The Titan Alpha is ideal for shops, take-aways and smaller commercial outlets.



TITAN ALPHA

DIMENSIONS

H: 30.5cm W: 35cm D: 15cm

WEIGHT

4kg

COVERAGE

Wall mounted: 80m² / Ceiling-suspended - Freestanding: 160m²

FINISH



White

TUBE DATA

• 2 x 15-Watt 12" long PestWest Quantum® tubes

Decorative and Commercial Sticky Traps

Find us on:    

The decorative and commercial sticky trap units have been designed specifically for areas where fly control should be hidden from view, with decorative and unique front covers that hide the glue board and insect catch.



Decorative and Commercial Sticky Traps

Find us on:



Designed for front-of-house areas where fly control should be hidden from view, the elegant and decorative design of the Sunburst® conceals the glue board and the insects caught.

Discreet, stylish and environmentally responsible, the Sunburst is ideal for hotels, restaurants, bars, and retail shops. These all metal units can be placed on a tabletop or mounted on the wall.



SUNBURST®

DIMENSIONS

H: 31cm W: 23cm D: 10cm

WEIGHT

2kg

COVERAGE

Wall mounted / Freestanding: 35m²

FINISH

 White  Silver-grey  Black

TUBE DATA

- 1 x 20-Watt BL compact tube
- Integrated electronic ballast

Decorative and Commercial Sticky Traps

Find us on:



The Sunburst® TAB is the latest addition to the Sunburst range. It is destined for catering outlets in both front and back-of-house areas thanks to its concealed fly catch behind a stainless steel, black or white cover.

Versatile, it can be wall-mounted vertically and horizontally or suspended from the ceiling. A high quality 24 Watt compact tube powered by an electronic ballast and backed by an aluminium reflector ensures optimum fly control and reduced electricity costs.



SUNBURST® TAB

DIMENSIONS

H: 25.5cm W: 42.5cm D: 10cm

WEIGHT

1.2kg

COVERAGE

Wall mounted/ Ceiling-suspended: 50m²

FINISH



Black



Stainless Steel



White

TUBE DATA

- 1 x 24 - Watt Compact tube
- Powered by an electronic ballast

Specialist Range

Find us on:



The specialist range provides special safety features such as high IP ratings and flameproof electrical enclosures giving you protection against the most hazardous and potentially dangerous areas.

The units are built to the highest possible specifications and accredited to the ultimate safety certification for electrical equipment.

This means that sensitive and often highly dangerous areas (ATEX classified zones) can be protected without compromising safety standards or insurance requirements.



Specialist
Range

Find us on:



The new Chameleon® EXG X LED is fully ATEX certified allowing its installation in zones where there is a risk of explosion due to a high concentration of gas or dust in the atmosphere such as: distilleries, sugar refineries, and in the pharmaceutical and petrochemical industries.

The Chameleon® EXG X is designed to comply with exacting ATEX standards (ATEX Directives 99/92/EC and 94/9/EC) and is made from the highest quality materials to give a fully corrosion-resistant construction using 304-brushed stainless steel and Marine-grade aluminum alloy. It is designed for use in ATEX zones 2, 1, 22 and 21.

Fitted with two Quantum® X LED shatterproof tubes, backed by a polished aluminum reflector and two large specially formulated LED glue boards.

Chameleon® EXG

QUANTUM
LED

DIMENSIONS

H: 81.5cm W: 94cm D: 18cm

WEIGHT

12kg

COVERAGE

Wall mounted: 110-130m²

FINISH

Stainless Steel and Aluminum alloy

TUBE DATA

- 2x Quantum® X LED tubes
- Shatterproof coating with industry compliant FEP
- Powered by a state of the art LED driver



Find us on:



The Chameleon® Qualis IP is designed to provide sustainable flying insect control in harsh industrial environments, notably in areas that are steam-cleaned, hosed down and are constantly damp and corrosive, e.g., dairies, abattoirs, and industrial kitchens.

All stainless steel and IP66 certified, it is fitted with next generation Quantum® X LED filament tubes, offering class leading energy-efficient flying insect control based on superior UVA light distribution gained from over 400 emission points per tube.

Durable, easy to service and maintain, with fast access to the LED optimised glue board, the Qualis IP only requires one replacement of the LED tubes every 3 years. No mercury, electrical consumption reduced to just 13.5W, low carbon and plastic footprints.

Chameleon® QUALIS IP

QUANTUM
LED

DIMENSIONS

H: 32cm W: 64cm D: 5.5cm

WEIGHT

5.6kg

COVERAGE

Wall mounted: 90-120m²

FINISH

■ Stainless Steel

TUBE DATA

- 2x Quantum® X LED tubes
- Shatterproof coating with industry compliant FEP
- Powered by a state of the art LED driver



Specialist
Range

Find us on:    



Chameleon® 4x4 Chameleon® 4x4 EX

DIMENSIONS

H: 61.5cm W: 63.5cm D: 16.5cm



WEIGHT

Chameleon® 4x4: 11.75kg - Chameleon® 4x4EX: 15.5kg

COVERAGE

Ceiling-suspended: 440m²

FINISH

-  Chameleon® 4x4 White
-  Chameleon® 4x4EX Stainless Steel

TUBE DATA

- 4 x 40-Watt PestWest Quantum® tubes
- Shatterproof coating with industry compliant FEP
- Reflectobakt® technology
- Powered by an electronic ballast

The Chameleon® 4x4 is a powerful high capacity sticky trap, which is particularly suited for large open areas in industrial food premises.

An advanced electronic ballast circuitry reduces the running costs and increases efficiency. The absence of starters and the easy lateral insertion and withdrawal of boards facilitate servicing.

The Chameleon® 4x4 EX is an ATEX compliant all stainless steel industrial UV fly trap.

It is suitable for use in potentially explosive atmospheres in ATEX zone 22 classified areas. Its IP65 rating also allows installation in damp, dusty or corrosive environments. This powerful unit covers large industrial areas trapping even the smallest insects on its double-sided board.

Specialist
Range

Find us on:



TITAN²⁰⁰IP

Easy to install and with low running costs this weatherproof design is perfect for the agricultural market and notably in farms with livestock.

The Titan 200 IP is robust and powerful with a metal casing and a quality industrial transformer that will efficiently eradicate flying insects for years. Its servicing is quick with easy access to the catch-tray and the highly powerful 20 Watt compact UV tube.

Splash-proof rated to IPX4 suitable for farm conditions. All-around and environmentally responsible insect attraction with no pesticide and no risk of chemical resistance.

DIMENSIONS

H: 47cm W: 30cm D: 30cm

WEIGHT

5kg

COVERAGE

Suspended / Freestanding: 160m²

FINISH

■ Black

TUBE DATA

- 1 x 20-Watt BL compact tube
- Integrated electronic ballast

Specialist
Range

Find us on:



The Nemesis® Quattro IP24 is an all stainless steel industrial model, which can withstand exposure to high humidity, water splashes and corrosive atmospheres.

It is both powerful and energy efficient, featuring high efficiency UVA fluorescent tubes powered by a state of the art electronic ballast for optimum fly control performance with lower running costs and reduced materials (glass and mercury notably). It is equipped with 'power-on' and high voltage indicators, the killing grid is extractable and the front guard can be locked in open position, which all contribute to the overall ease of servicing.

Nemesis® QUATTRO IP

DIMENSIONS

H: 42cm W: 65cm D: 18cm

WEIGHT

12kg

COVERAGE

Wall mounted: 240m² / Ceiling-suspended: 480m²

FINISH

■ Stainless Steel

TUBE DATA

- 4 x 14-watt T5 PestWest Quantum® tubes
- Shatterproof coating with industry compliant FEP
- Powered by an electronic ballast

Find us on:



ONLINE REMOTE FLYING INSECT CONTROL SYSTEM

Stay permanently connected with end customers. Assess remotely the situation pertinent to fly control in real time and plan on-site visits accordingly.

Automatic data archiving and trend analysis.
A more proactive and convenient way of operating.

flyDetect® - the future of remote flying insect control.

Flying Insect Surveillance Sticky Trap

Find us on:

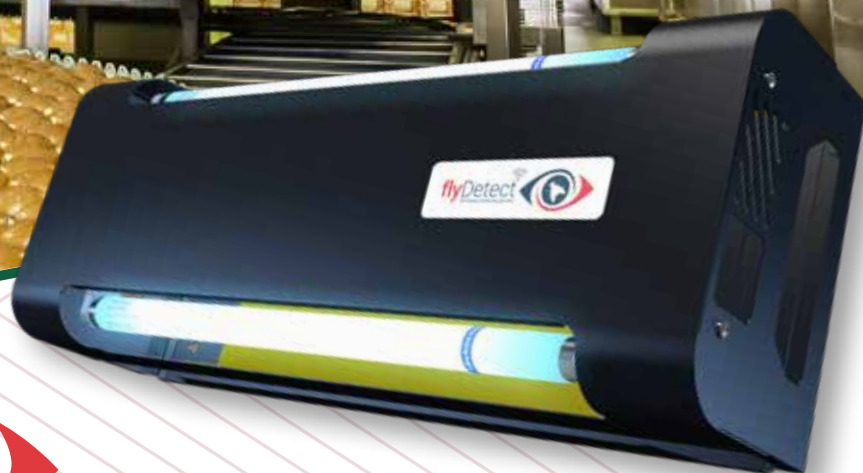

flyDetect® from PestWest®, the industry leader in online flying insect monitoring.

- 24/7 remote monitoring system.
- Immediate notification of emerging pest infestations.
- Customisable alert levels.
- Built-in high resolution camera captures the entire sticky board.
- Set up and monitor multiple clients.
- The trapped flying insect population is quantified and archived together with a temperature and humidity reading, alongside each sticky board image.
- Scheduled UV-A tube and sticky board change notifications.
- Multiple connectivity options (Wifi, Ethernet and Cellular).
- The flyDetect® app is available on multiple platforms (smartphones and computers).

DIMENSIONS

H: 22cm W: 59.5cm D: 15cm

WEIGHT

4.5kg

COVERAGE

Wall mounted/ Ceiling-suspended: 70m²

FINISH

Black 

TUBE DATA

- 2 x 15-Watt PestWest Quantum® tubes
- Shatterproof coating with industry compliant FEP
- Powered by an electronic ballast



Confidence in
Fly Control

Ancillary Products - PestWest® Sticky Boards

Find us on:    

The PestWest range of outstanding sticky boards ensures effectiveness and ease of service to provide a difference that sets them apart from the rest.

The effectiveness and ease of service of PestWest sticky boards are achieved by using high quality raw materials and a production process that matches the specific features of our UV and UV LED fly control units.



Ancillary Products - PestWest® Sticky Boards

Find us on:



Chameleon® Qualis

With a LED optimised glue board



LED
OPTIMISED

Sticky boards with a difference!

The PestWest sticky board range features:

- Laminated board construction to eliminate warping and facilitate servicing
- Insect retention and UVA resistance are optimised with a unique hot melt adhesive coating
- Easy to install with a fast release silicon paper that does not affect the glue coating
- Treated card prevents moisture penetration and ensures conformal glue coating for improved insect retention
- Used as part of an IPM program, this comprehensive range includes Grey or Yellow monitoring boards with a tabulated grid pattern to facilitate insect counting and identification
- Solvent free glue and use of recycled cardboard reduces environmental impact
- Size-optimised to fit a wide range of fly trap models, reducing stock requirements
- Long shelf life to minimise stocking issues

Dedicated boards

Due to the fact that UV LED light is much cooler than traditional UV fluorescent light, a specifically formulated adhesive coating is required to achieve optimised performance. Within traditional UV fly traps, the UV fluorescent tubes generate heat, so that the adhesive on the board gets 'sticky' enough to retain insects, but not too fluid, because otherwise it would literally run off the sticky board. Meanwhile, the heat generated by UV LED tubes is too insignificant to repeat the same process, which is why PestWest has done extensive research in order to create a dedicated sticky board, optimised to work with LED technology and the Quantum® X range in particular.

To achieve maximum efficacy, it is vital that only the dedicated PestWest LED sticky board is used for all PestWest LED models!

Find us on:    

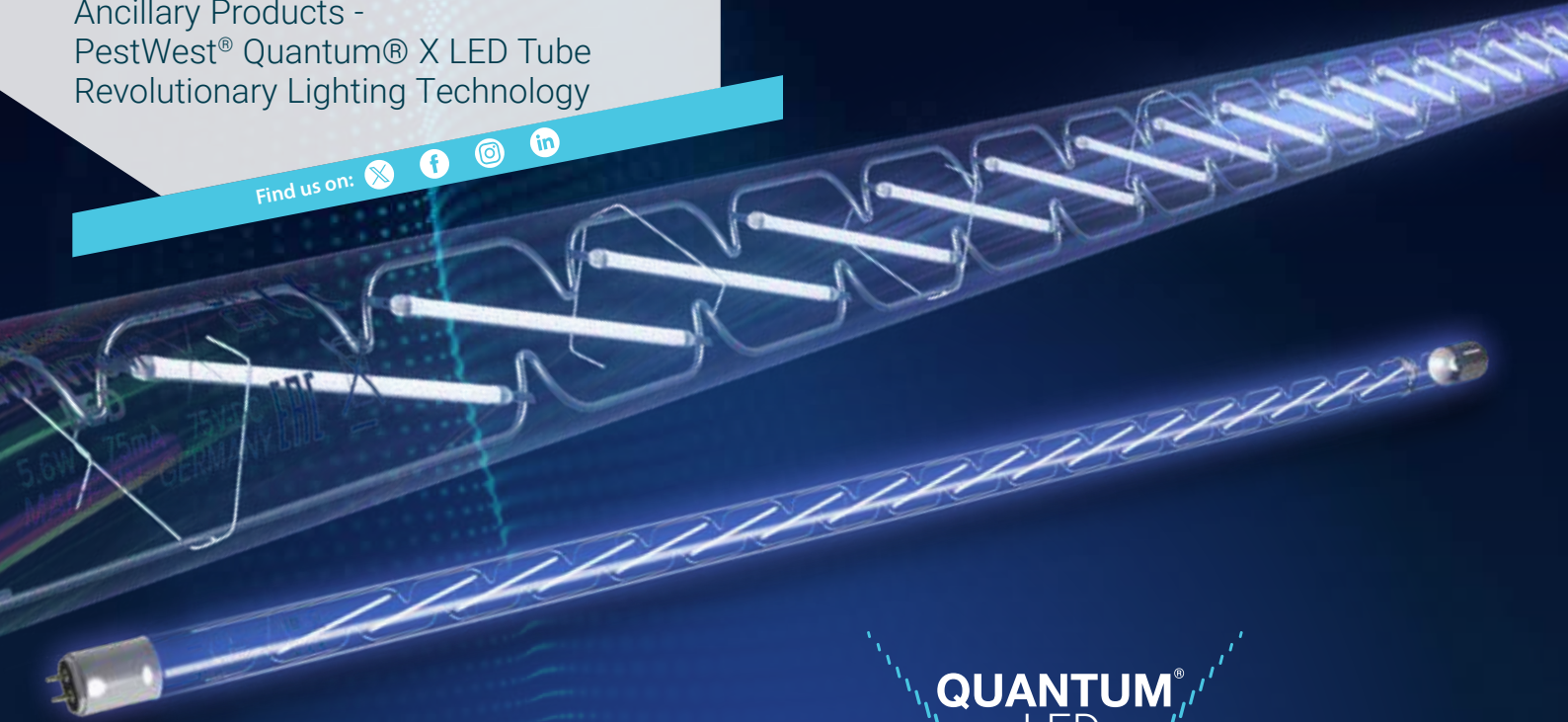

360°
 UV BEAM
 Quantum® X
 filament LED



OTHER LED TUBES
 RESTRICTED HARSH 120° BEAM

QUANTUM®
 LED



- No mercury
- Environmentally sustainable
- FEP shatterproof coated
- Future-proof

ENERGY SAVINGS

Comparison of power consumption in Watts

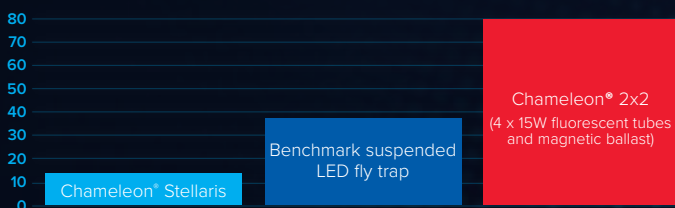

The Chameleon Stellaris consumes 6 times less than its equivalent Chameleon model with fluorescent tubes and 3 times less than most other LED suspended models with a similar coverage area.

Why is Quantum® X different?

- Unrivalled distribution of UVA LED light significantly improving flying insect control.
- Minimal energy consumption without any dimming – typically over 35% less than other LED technologies.
- Lower environmental impact: zero mercury content & 3-year tube lifespan.

A unique design, lightyears ahead of the rest

- No dazzling UV spots as with traditional LED chip technology used by other manufacturers. These can be uncomfortable for people and too intense for attracting flies.
- Unique Helium LED cooling gas for maximum reliability and longer lasting performance.
- Shatterproof coating containing all elements in the event of a breakage.

Ancillary Products -
PestWest® Shatterproof Tubes
High Performance and Safety

Find us on:



Why choose PestWest UVA shatterproof tubes for your fly control units?

UV tubes are at the heart of a fly killer. Their quality dictates the attractiveness of the unit to flying insects and therefore its effectiveness. Don't compromise your reputation with low quality shatterproof tubes!

PestWest UV shatterproof linear tubes offer:

- 100% European technology
- Higher and more durable UV attraction power
- Fluorescent tubes engineered and manufactured in Europe
- Industry compliant FEP shatterproof coating: 5% UVA light loss maximum and glass retention under impact to EN 61549
- Original large diameter 20 and 40 Watt tubes available (T12)
- Tried and trusted brand

Confidence in
Fly Control

Find us on:



UV fly killers

- To maintain maximum effectiveness, fluorescent tubes should be changed at least every 12 months, preferably at the onset of warmer weather.
- PesWest® tubes are recommended, as their effective lifespan is longer than most other fluorescent tubes, which reduces the amount of maintenance required.
- If the unit requires starters, replace them at the same time that you change the tubes.

Additionally for UV sticky traps

- Use Reflectobakt® sleeves to maintain optimum fly control performance particularly when the glue board and the fluorescent tubes are placed close together.
- Replace the sticky boards at least every 2 months to ensure maximum efficacy.

Additionally for EFks

- Use a grid tester to test the killing grid without shorting the high tension current onto the metal body of the machine, as often happens when using a conventional screwdriver (unless the unit has a high voltage 'grid-on' indicator like the Nemesis Quattro line).
- Brush down the killing grid (only when it is turned off!) to remove insect fragments.
- Empty the catch tray frequently.

Quantum® X LED UV fly control units

The Quantum® X UV LED tubes have a life span of 3 years. Switch off the machine before servicing. It must be noted that LED tubes are nothing like fluorescent tubes, failure to disconnect the unit from power when removing or inserting a tube is likely to permanently damage the LEDs. This will result in the LED tube being irreparably damaged.

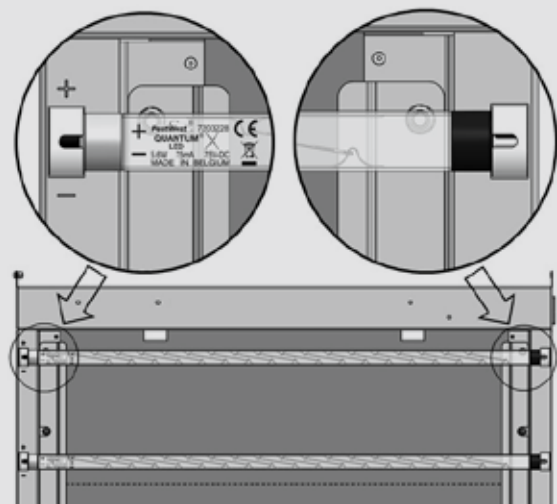

- When fitting the LED tubes ensure the silver end cap is fitted into the left-hand side (LHS) tube holders, with the + & – symbols correctly aligned.
- The black non voltage end cap should be fitted into the right-hand side (RHS) tube holders.
- The LED tubes will not operate in any other configuration.
- The unit will only operate with Quantum® X LED 370nm 550mm T5 tubes.

Find us on:



How to choose the right fly killer

Front of House

Front of house installations are typically in restaurants, bars, cafés and hotel lobbies. For front of house areas the requirements are usually for aesthetically pleasing designs that blend in with the décor and are silent in operation. For these installations sticky board traps designed as wall sconces or uplighters are an ideal choice.

Commercial

Commercial installations are usually small, medium and large retailers and kitchens. They are often places where food is being prepared or where open food is displayed. For hygiene and aesthetic reasons stainless steel construction is often specified. These demanding areas usually require large and powerful UV fly control units. Many installations are

in public view so the design may still require aesthetically pleasing machines. Often a mixture of units that look like commercial equipment and units with discretion covers fitted are used.

Industrial

Industrial installations are usually factories and warehouses with large areas that need to be protected. The recommended units are typically sticky board models with powerful and visible from view UV tubes for greater insect attraction. Units should be easy to service and clean, with smooth surfaces and few potential dirt traps. Stainless steel options are often preferred.

For a PestWest solution to all your flying insect control needs, refer to the model selection guide below.

	Titan Alpha	Titan 300	Nemesis Quattro	Titan 200 IP	Nemesis Quattro IP	Uplight	Sunburst	Sunburst TAB	Chameleon 1x2	Chameleon 1x2 Discretion	Chameleon 2x2	Chameleon 4x4	Chameleon 4x4 EX	Chameleon EXG X	flyDetect®	Chameleon Qualis	Chameleon Qualis IP	Chameleon Stellaris	Chameleon Sirius X	ON-TOP PRO(2)X
Front of House						✓	✓	✓		✓									✓	✓
Commercial	✓	✓	✓	✓				✓	✓	✓					✓	✓	✓	✓		
Industrial			✓	✓	✓				✓		✓	✓	✓	✓	✓	✓	✓	✓		
Dry and Clean	✓	✓	✓			✓	✓	✓	✓	✓	✓	✓			✓	✓		✓	✓	✓
Damp, steam-cleaned, hosed down				✓	✓								✓	✓			✓			
Risk of explosion (ATEX)													✓	✓						
Shatterproof Tubes		✓	✓		✓	✓			✓	✓	✓	✓	✓	✓	✓	✓	✓	✓	✓	✓
Wall Mounting	✓	✓	✓		✓	✓	✓	✓	✓	✓				✓	✓	✓	✓		✓	
Ceiling Suspension	✓	✓	✓	✓	✓			✓			✓	✓	✓		✓			✓		✓
Free Standing	✓	✓	✓	✓			✓		✓	✓										
Area of Coverage m ²	160/80	180/90	480/240	160	480/240	40	35	50	90	70	180	440	440	110-130	70	90-120	90-120	180-220	50-60	50-60
Electronic Ballast			✓	✓	✓		✓	✓				✓	✓		✓					
CE and UKCA marks	✓	✓	✓	✓	✓	✓	✓	✓	✓	✓	✓	✓	✓	✓	✓	✓	✓	✓	✓	✓
EN 60335-2-59 & 60335-1	✓	✓	✓	✓	✓	✓	✓	✓	✓	✓	✓	✓	✓	✓	✓	✓	✓	✓	✓	✓
Sticky Board Fly Trap						✓	✓	✓	✓	✓	✓	✓	✓	✓	✓	✓	✓	✓	✓	✓
Electronic Fly Killer	✓	✓	✓	✓	✓															

N.B.: the stainless steel versions of the Titan 300, Chameleon 1x2, 2x2, and Qualis are suitable for areas with moderate levels of humidity and corrosive substances.

Find us on:



All units operate under 220 - 240V, 50/60Hz mains supply. All models use RoHS compliant UVA fluorescent or UVA LED tubes, peaking at circa 365nm.

PROFESSIONAL LED STICKY TRAPS

Chameleon[®] Qualis page 6

	Power Consumption	13.5 Watt
	Tube Data - PestWest Quantum [®] X shatterproof LED	2x 5.6 Watt LED 21" / 55cm long / T5
	Starters (in series type)	None
	Coverage area Wall mounted	90-120m ²
	Coverage area Ceiling-suspended	n/a
	Dimensions H x W x D	30 x 57.5 x 4cm
	Weight	3.6kg

Chameleon[®] Stellaris page 7

	Power Consumption	13.5 Watt
	Tube Data - PestWest Quantum [®] X shatterproof LED	2x 5.6 Watt LED 21" / 55cm long / T5
	Starters (in series type)	None
	Coverage area Wall mounted	n/a
	Coverage area Ceiling-suspended	180-220m ²
	Dimensions H x W x D	42 x 59 x 16cm
	Weight	5.7kg

ON-TOP PRO X & ON-TOP PRO2 X page 8

	Power Consumption	13.5 Watt
	Tube Data - PestWest Quantum [®] X shatterproof LED	2x 5.6 Watt LED 21" / 55cm long / T5
	Starters (in series type)	None
	Coverage area Wall mounted	n/a
	Coverage area Ceiling-fitted	50-60m ²
	Dimensions H x W x D	OTP X: H: 59cm W: 59cm D: 15cm OTP2 X: H: 59cm W: 59cm D: 7cm
	Weight	5.6kg

Chameleon[®] Sirius X page 9

	Power Consumption	13.5 Watt
	Tube Data - PestWest Quantum [®] X shatterproof LED	2x 5.6 Watt LED 21" / 55cm long / T5
	Starters (in series type)	None
	Coverage area Wall mounted	50-60m ²
	Coverage area Ceiling-suspended	n/a
	Dimensions H x W x D	19 x 58 x 12cm
	Weight	3.1kg

PROFESSIONAL STICKY TRAPS

Chameleon[®] 1x2 page 11

	Power Consumption	45 Watt
	Tube Data - PestWest Quantum [®] BL	2 x 15 Watt shatterproof 18" / 45cm long / T8
	Starters (in series type)	2 x FS22 or S2
	Coverage area Wall mounted	90m ² freestanding bracket available
	Coverage area Ceiling-suspended	n/a
	Dimensions H x W x D	30 x 47.5 x 6.5cm
	Weight	4.3kg

Chameleon[®] 1x2 Discretion page 12

	Power Consumption	45 Watt
	Tube Data - PestWest Quantum [®] BL	2 x 15 Watt shatterproof 18" / 45cm long / T8
	Starters (in series type)	2 x FS22 or S2
	Coverage area Wall mounted	70m ² freestanding bracket available
	Coverage area Ceiling-suspended	n/a
	Dimensions H x W x D	30 x 47.5 x 6.5cm
	Weight	4.3kg

Chameleon[®] 2x2 page 13

	Power Consumption	80 Watt
	Tube Data - PestWest Quantum [®] BL	4 x 15 Watt shatterproof 18" / 45cm long / T8
	Starters (in series type)	4 x FS22 or S2
	Coverage area Wall mounted	n/a
	Coverage area Ceiling-suspended	180m ²
	Dimensions H x W x D	30 x 49.5 x 13cm
	Weight	6kg

Chameleon[®] Uplight page 14

	Power Consumption	25 Watt
	Tube Data - PestWest Quantum [®] BL	1 x 15 Watt shatterproof 18" / 45cm long / T8
	Starters (in series type)	1 x FS22 or S2
	Coverage area Wall mounted	40m ²
	Coverage area Ceiling-suspended	n/a
	Dimensions H x W x D	21 x 47 x 17cm
	Weight	3.7kg

ELECTRONIC FLY KILLERS (EFKS)

Nemesis[®] Quattro page 16

	Power Consumption	66 Watt
	Killing Grid Output	4300V 6.5mA
	Tube Data - PestWest Quantum [®] BL	4 x 14 Watt shatterproof 21" / 55cm long / T5
	Starters (in series type)	None
	Coverage area Wall mounted	240m ²
	Coverage area Ceiling-suspended	480m ²
	Dimensions H x W x D	42 x 65 x 18cm
	Weight	12kg

Titan[®] 300 page 17

	Power Consumption	50 Watt
	Killing Grid Output	3800V 9mA
	Tube Data - PestWest Quantum [®] BL	2 x 15 Watt shatterproof 18" / 45cm long / T8
	Starters (in series type)	2 x FS22 or S2
	Coverage area Wall mounted	90m ²
	Coverage area Ceiling-suspended	180m ²
	Dimensions H x W x D	33 x 49.5 x 13.5cm
	Weight	7.5kg

Titan[®] Alpha page 18

	Power Consumption	50 Watt
	Killing Grid Output	3800V 9mA
	Tube Data - PestWest Quantum [®] BL	2 x 15 Watt 12" / 30cm long / T5
	Starters (in series type)	2 x FS22 or S2
	Coverage area Wall mounted	80m ²
	Coverage area Ceiling-suspended	160m ²
	Dimensions H x W x D	30.5 x 35 x 15cm
	Weight	4kg

Product Specifications

Find us on:



DECORATIVE STICKY TRAPS

Sunburst* page 20

	Power Consumption	22 Watt
	Tube Data - BL 368nm	1 x 20 Watt compact
	Starters (in series type)	None
	Coverage area Wall mounted	35m ²
	Coverage area Freestanding	35m ²
	Dimensions H x W x D	31 x 23 x 10cm
	Weight	2kg

Sunburst TAB page 21

	Power Consumption	25 Watt
	Tube Data - BL 368nm	1 x 24 Watt compact
	Starters (in series type)	None
	Coverage area Wall mounted	50m ²
	Coverage area Ceiling-suspended	50m ²
	Dimensions H x W x D	25.5 x 42.5 x 10cm
	Weight	1.2kg

SPECIALIST RANGE

Chameleon* EXG X page 23

	Power Consumption	13.5 Watt
	Tube Data - PestWest Quantum* X shatterproof LED	2x 5.6 Watt LED 21" / 55cm long/T5
	Starters (in series type)	None
	Coverage area Wall mounted	110-130m ²
	Coverage area Ceiling-suspended	n/a
	Dimensions H x W x D	81.5 x 94 x 18cm
	Weight	12kg

Chameleon* Qualis IP page 24

	Power Consumption	13.5 Watt
	Tube Data - PestWest Quantum* X shatterproof LED	2x 5.6 Watt LED 21" / 55cm long/T5
	Starters (in series type)	None
	Coverage area Wall mounted	90-120m ²
	Coverage area Ceiling-suspended	n/a
	Dimensions H x W x D	32 x 64 x 5.5cm
	Weight	5.6kg

Chameleon* 4x4EX page 25

	Power Consumption	190 Watt
	Tube Data - PestWest Quantum* BL	4 x 40 Watt shatterproof 24" / 60cm long / T12
	Starters (in series type)	None
	Coverage area Wall mounted	n/a
	Coverage area Ceiling-suspended	440m ²
	Dimensions H x W x D	61.5 x 63.5 x 16.5cm
	Weight	15.5kg

Chameleon* 4x4 White page 25

	Power Consumption	190 Watt
	Tube Data - PestWest Quantum* BL	4 x 40 Watt shatterproof 24" / 60cm long / T12
	Starters (in series type)	None
	Coverage area Wall mounted	n/a
	Coverage area Ceiling-suspended	440m ²
	Dimensions H x W x D	61.5 x 63.5 x 16.5cm
	Weight	11.75kg

Titan* 200 IP page 26

	Power Consumption	30 Watt
	Killing Grid Output	3500V 10mA
	Tube Data - BL 368nm	1 x 20 Watt compact
	Starters (in series type)	None
	Coverage area Freestanding	160m ²
	Coverage area Ceiling-suspended	160m ²
	Dimensions H x W x D	47 x 30 x 30cm
Weight	5kg	

Nemesis* Quattro IP page 27

	Power Consumption	66 Watt
	Killing Grid Output	4300V 6.5mA
	Tube Data - PestWest Quantum* BL	4 x 14 Watt shatterproof 21" / 55cm long / T5
	Starters (in series type)	None
	Coverage area Wall mounted	240m ²
	Coverage area Ceiling-suspended	480m ²
	Dimensions H x W x D	42 x 65 x 18cm
Weight	12kg	

FLYING INSECT SURVEILLANCE STICKY TRAP

flyDetect* page 29

	Power Consumption	40 Watt
	Tube Data - PestWest Quantum* BL	2 x 15 Watt shatterproof 18" / 45cm long / T8
	Starters (in series type)	None
	Coverage area Wall mounted	70m ²
	Coverage area Ceiling-suspended	70m ²
	Dimensions H x W x D	22 x 59.5 x 15cm
	Weight	4.5kg

Find us on:



Lesser Housefly
Fannia canicularis

Features

Grey thorax with three indistinct longitudinal stripes. Abdomen has extensive area of yellow at base.

Control

PestWest sticky traps and fly killers are effective at controlling the lesser housefly.

5-6mm



Mosquitoes
Culex spp.

Features

Slender, long-legged insect with forward-pointing, piercing and sucking mouthparts. Wingspan 7-15mm.

Control

PestWest units can be effective at catching mosquitoes.

7-15mm



Blowfly
Calliphora spp.

Features

Thorax and abdomen black/blue in colour and often with a metallic appearance. Wingspan 18-20mm.

Control

All PestWest fly killers are a very effective step in controlling these pests.

9-13mm



Wasp
Vespula spp.

Features

Black head and thorax, black and yellow patterning on abdomen.

Control

PestWest sticky traps and electronic fly killers are particularly effective at attracting and controlling wasps.

15-20mm



Cluster Fly
Pollenia rudis

Features

Large flies, wingspan up to 20mm. Thorax distinctive dark grey/olive colour covered in golden hairs.

Control

Areas where flies congregate should be treated with residual insecticide. PestWest fly killers are a very effective step in controlling cluster flies.

10mm



Scuttle Fly/Phorid Fly
Megaselia spp.

Features

Thorax dark brown/tan with distinctive humped appearance.

Control

Chameleon® sticky traps and electronic fly killers are extremely effective at attracting and controlling these pests.

3-4mm



Mushroom/Fungus Fly
Sciara thomae

Features

Small insects, wingspan 14-15mm. Black head, thorax and abdomen. Thorax has humped appearance.

Control

Chameleon® sticky traps are a very effective step in controlling mushroom flies.

5-6mm



Biting Midge
Culicoides spp.

Features

Dark brown/black in colour. Wingspan 3-4mm. Will swarm in large numbers and inflict bites.

Control

Insect repellents should be used when outdoors to prevent bites. Chameleon® sticky traps will attract and control midges.

1.2-1.5mm



Fruit Fly
Drosophila spp.

Features

Small yellowish brown with darkly striped abdomen. Prominent red eyes.

Control

Chameleon® sticky traps are extremely effective at controlling these smaller insects.

3mm



Common Housefly
Musca domestica

Features

Thorax grey with four longitudinal dark stripes. Sides of abdomen are yellowish and may be transparent. A dark band covers the final abdomen segments.

Control

PestWest fly killers and sticky traps will effectively control houseflies.

6-8mm



Distributed by:



PestWest Electronics Limited,
West Yorkshire, United Kingdom
Tel: +44 (0) 1924 268500
email: info@pestwest.com
www.pestwest.com

Confidence in
Fly Control